

<N 5! J

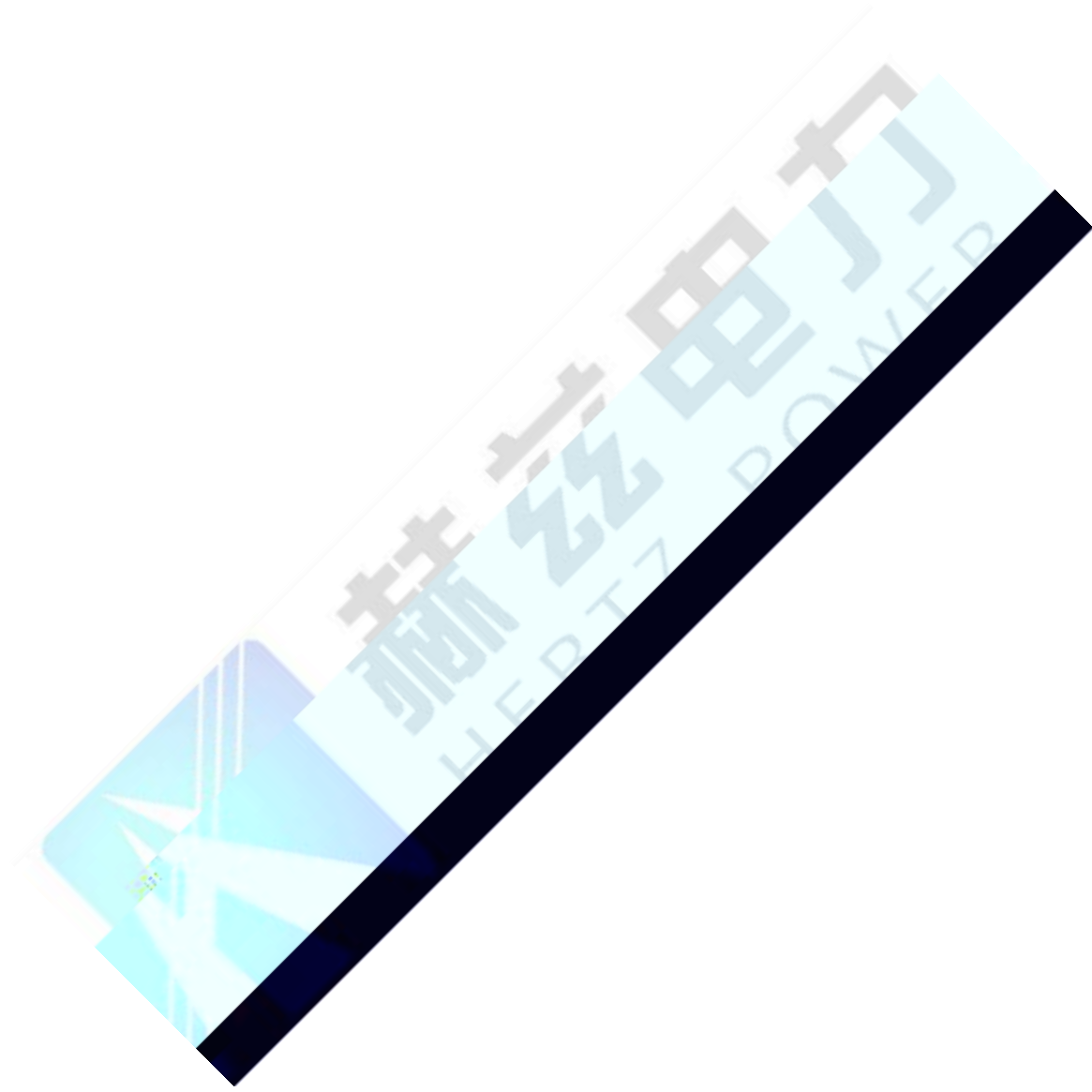

HZFA-V

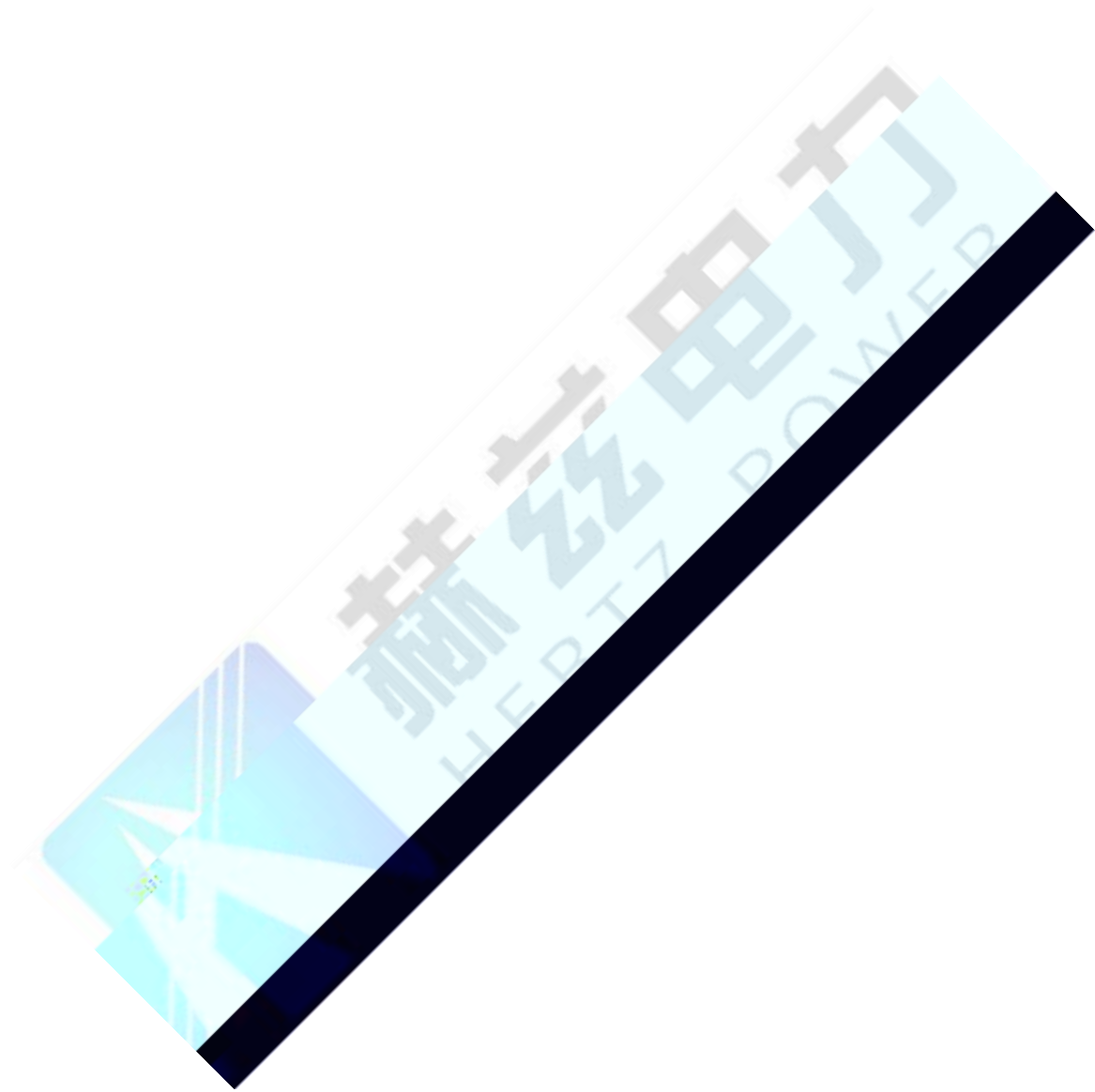

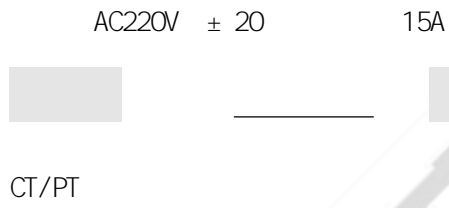

PT

CT

PT

/

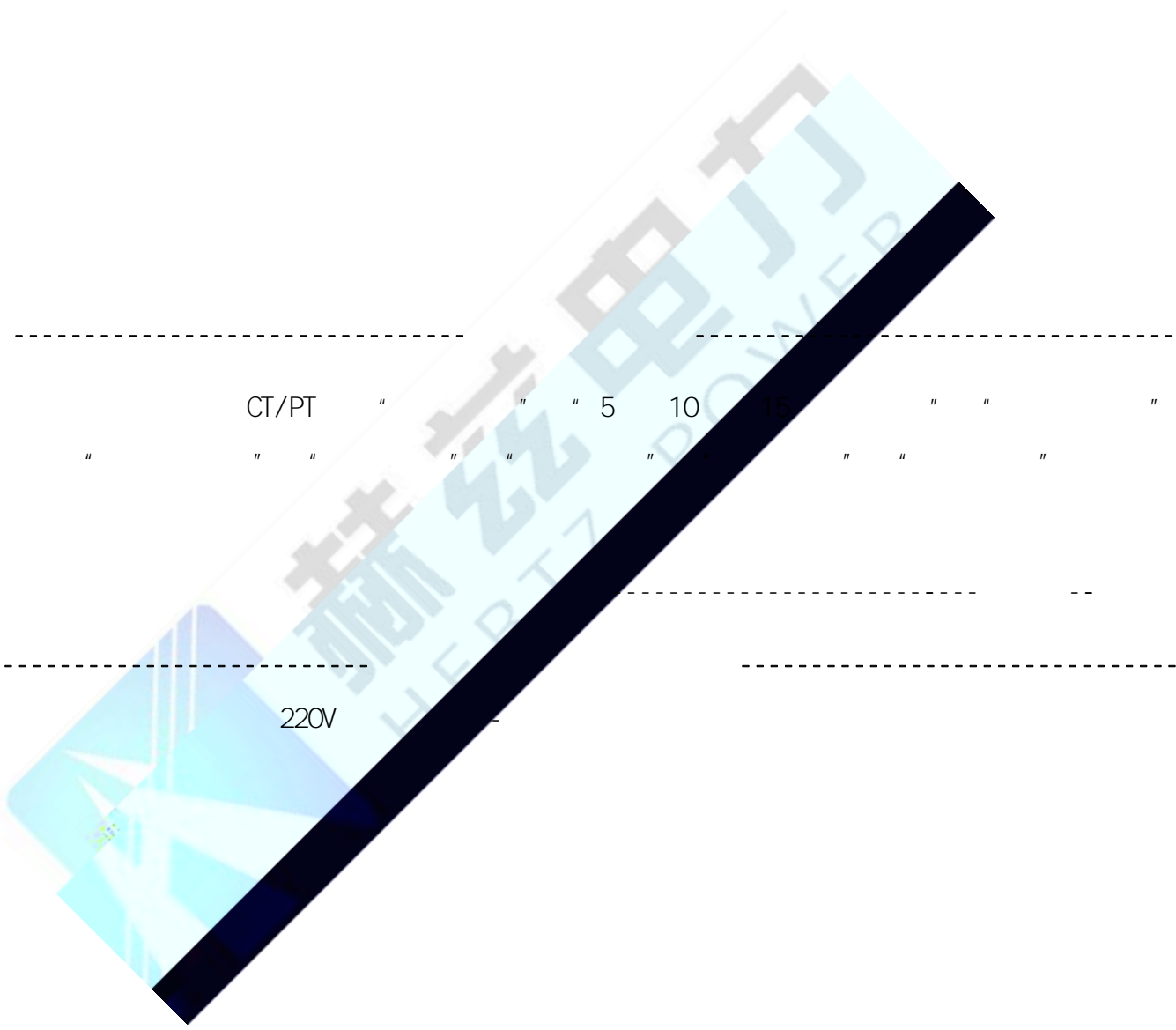
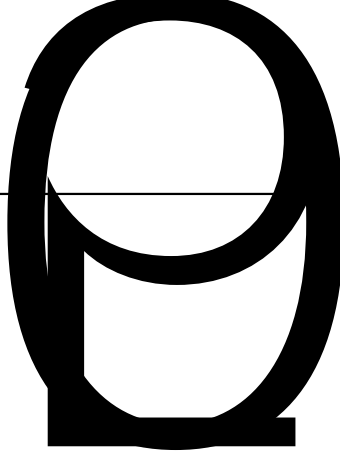

2000

RS232

U

20Kg

CT	220V	0—1000V	3KVA	< 0.5%
PT	220V	0—330V	3KVA	< 0.5%
CT	220V	0-8V		< 0.5%
PT	220V	0—1000V		< 0.5%
CT	-	-		

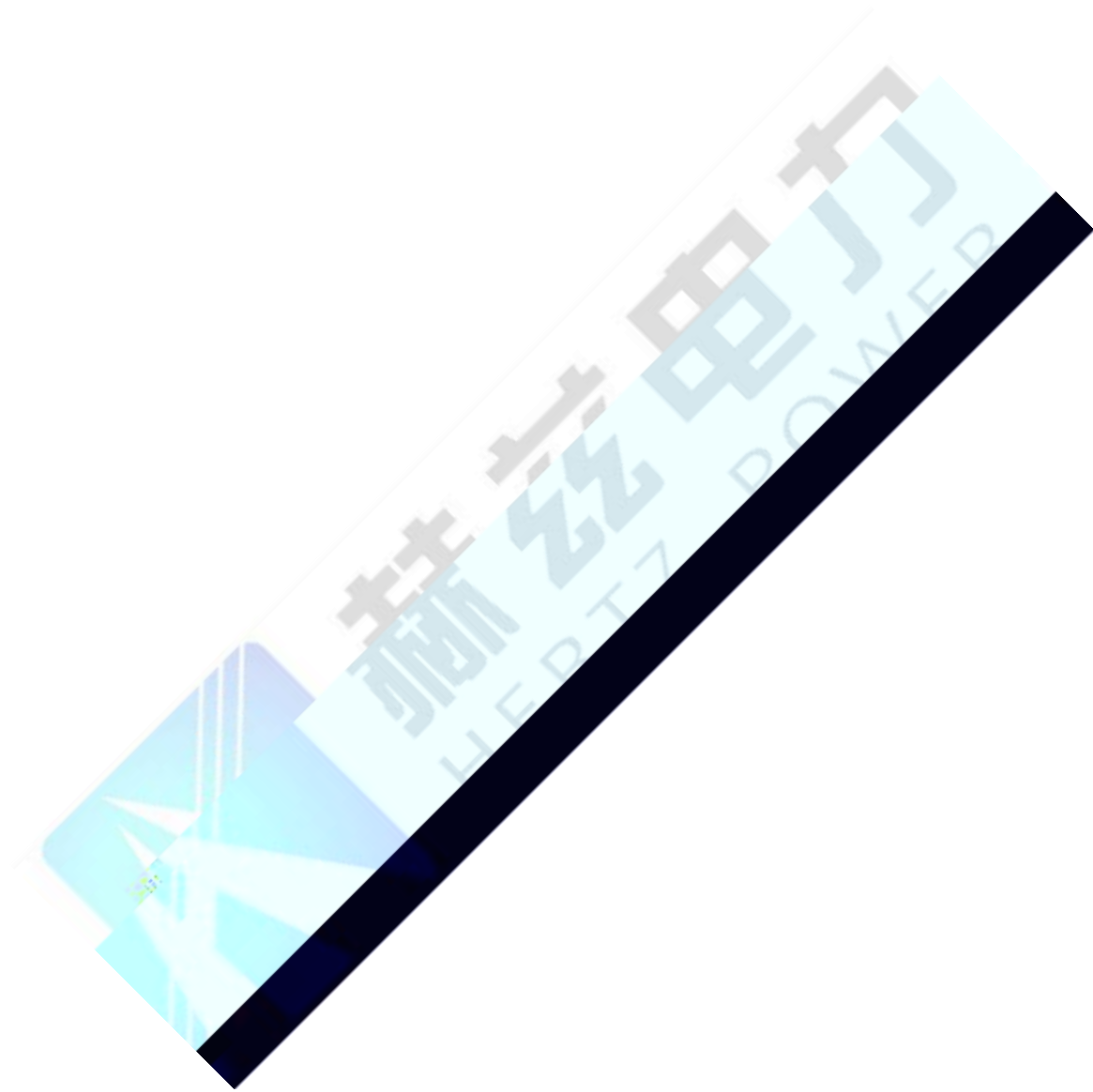

220V

CT PT U

全功能互感器综合测试仪

08-12-28 15:30



CT 参数设置

编号: ABC001

相序: A

Kn: 1

变比: 1000:5

CT

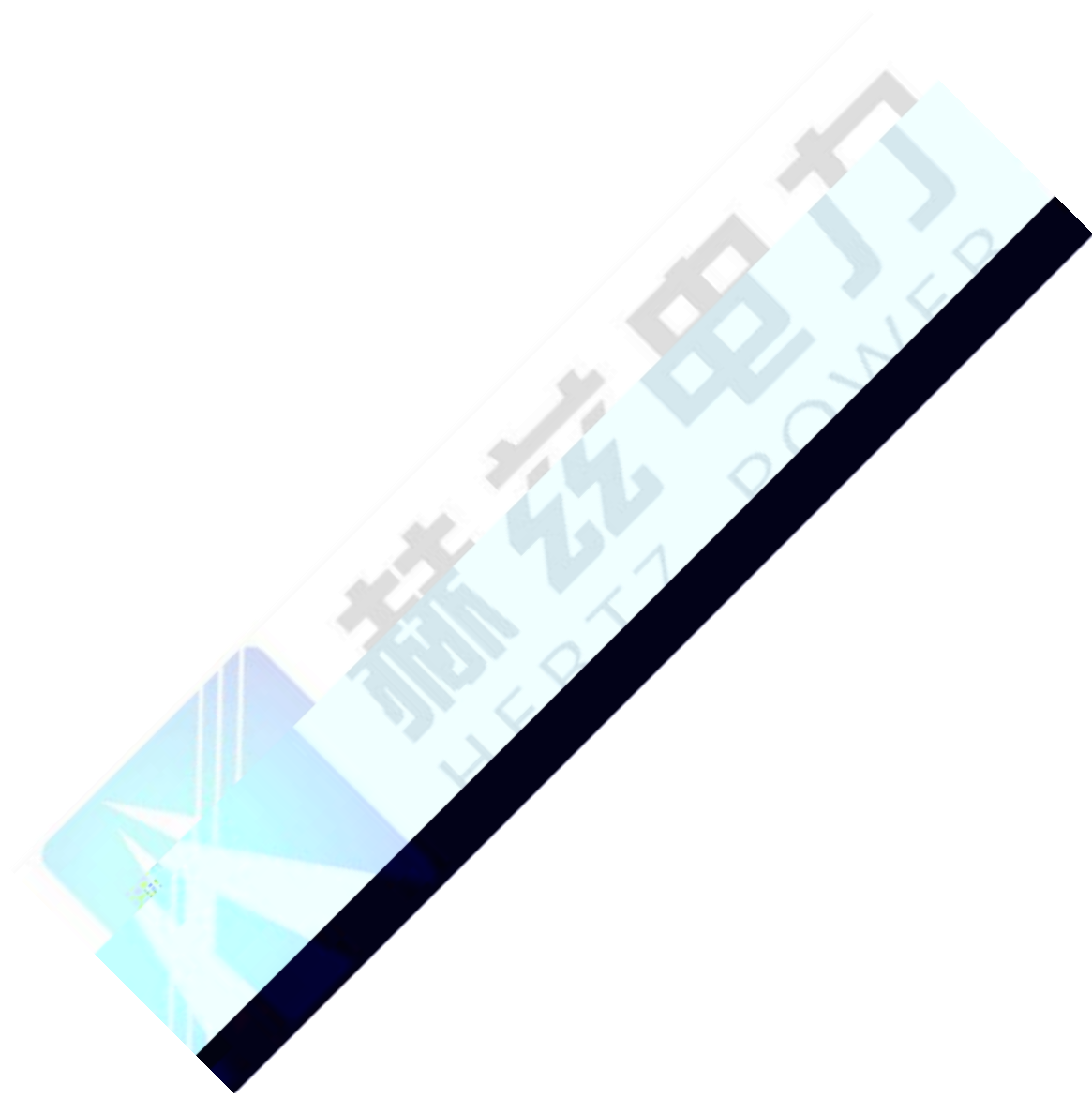

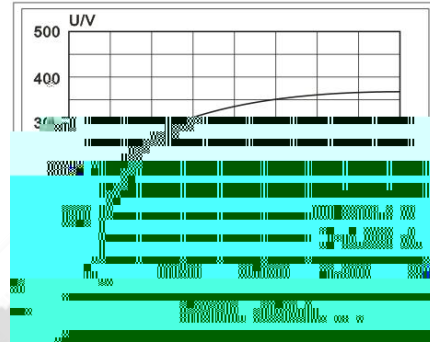
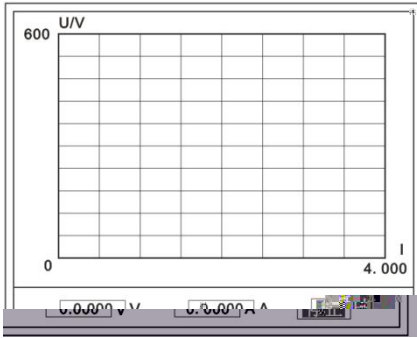
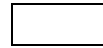
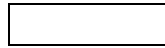

d.



()

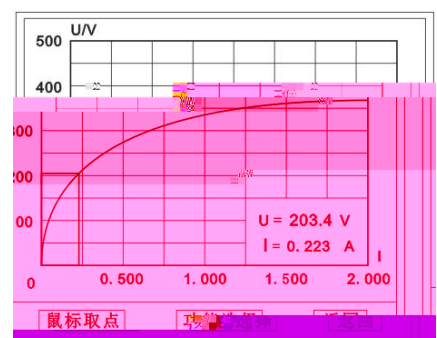

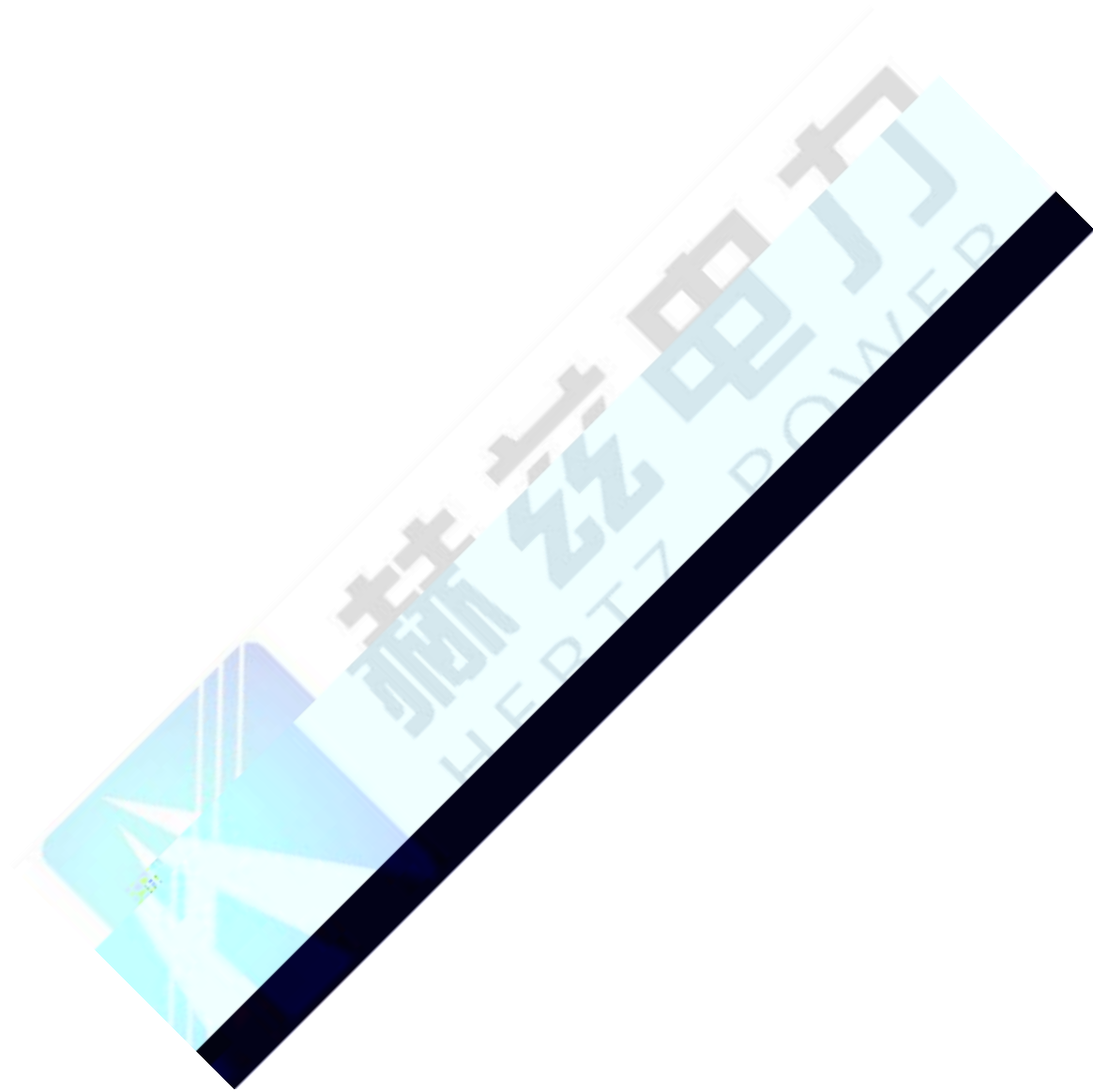

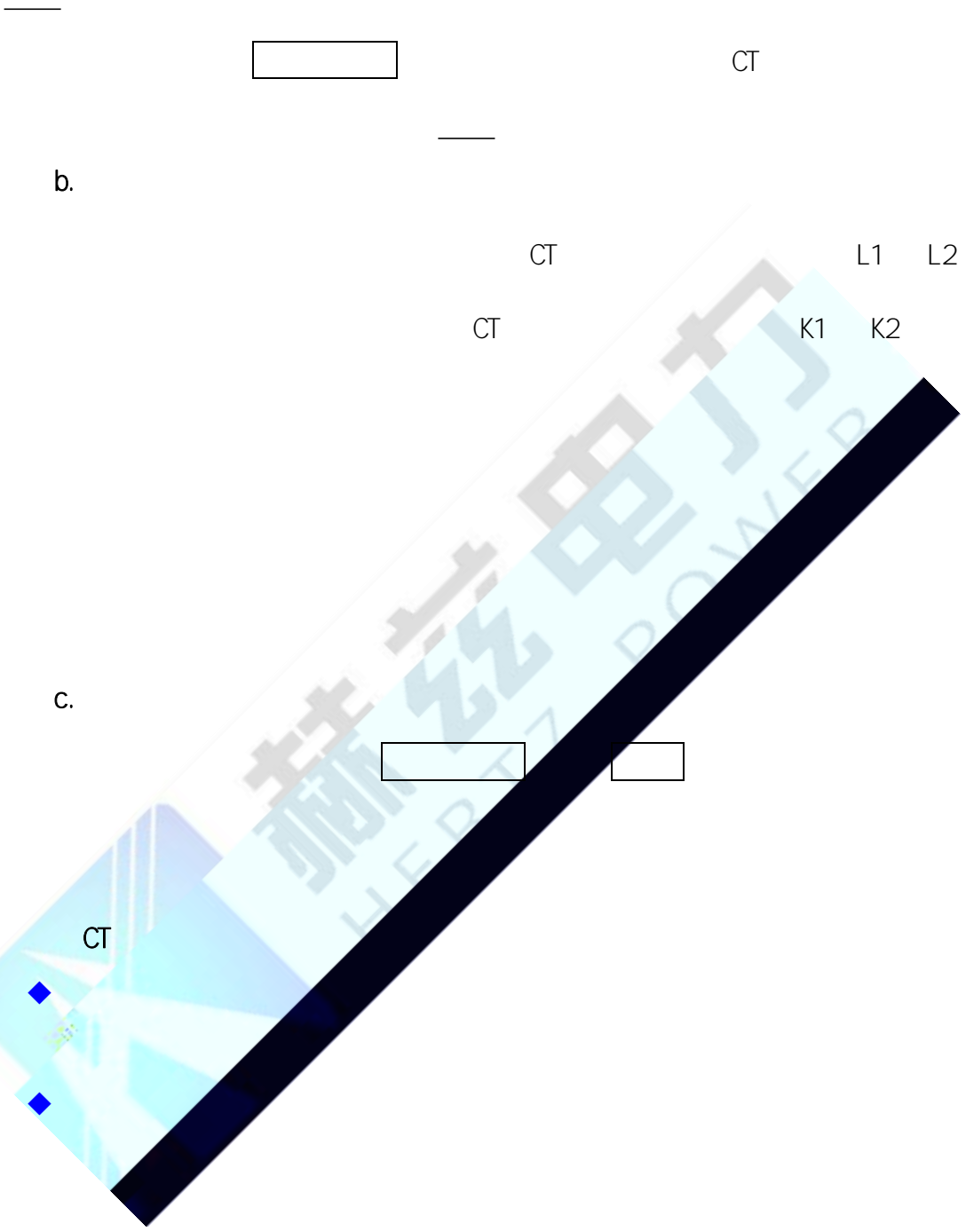

e.

5 200A



E.



4. PT



CT

CT

A. PT

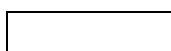
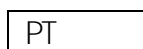

a.



0 - 3 A



0-330V



b.

B. PT

PT

PT

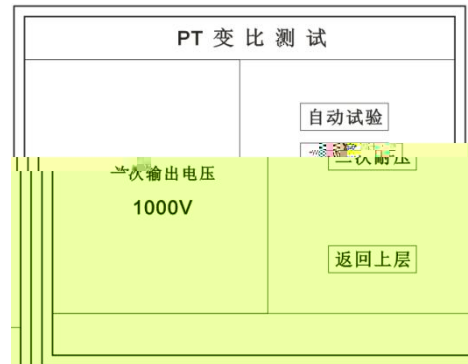

a.



0 - 1000

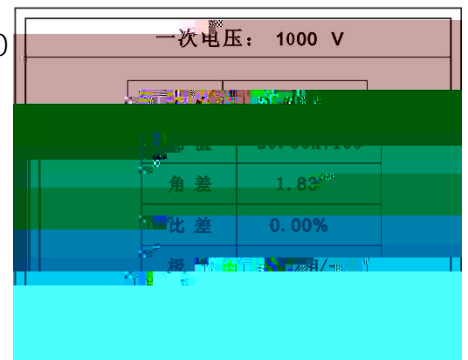

5

b.

PT

a x

c.

5

1000V

PT测试——二次耐压

一次电压: 1000 V
绝缘电流: 0.001 V

累计时间 1: 00

5.

A. CT

a.

b.

CT

PT

数据查询

请输入:

编号: ABC001
日期: 09年 5月 1日

确定 取消

N	编号	相序	Kn	时间	类型
1	ABC001	A		09-05-01-15:23	变比
2	ABC001	A	1	09-05-01-15:23	变比
3	ABC001	A	1	09-05-01-15:23	伏安
4	ABC001	A	2	09-05-01-15:23	伏安

后页 返回



6. U

U

5

U

U

U

U

U

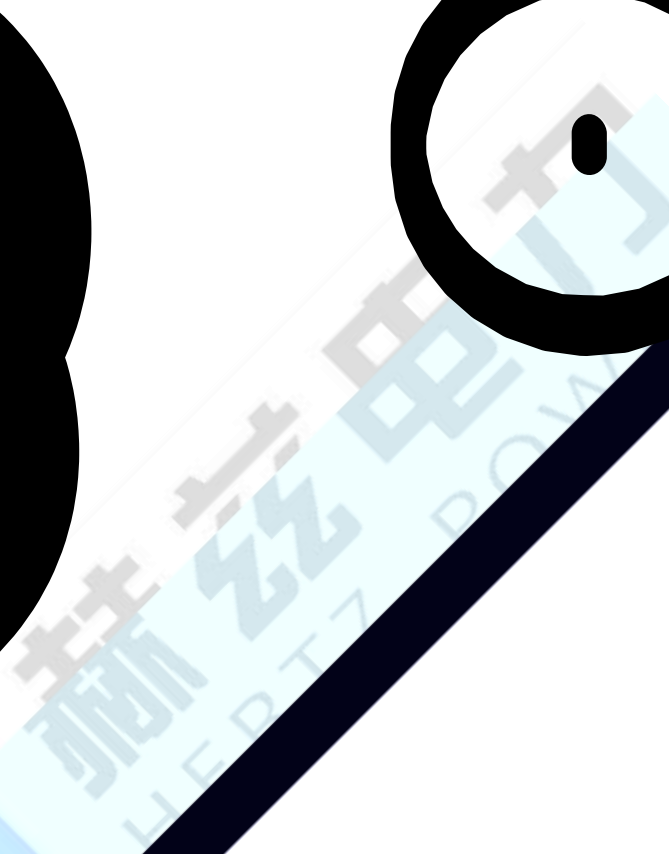
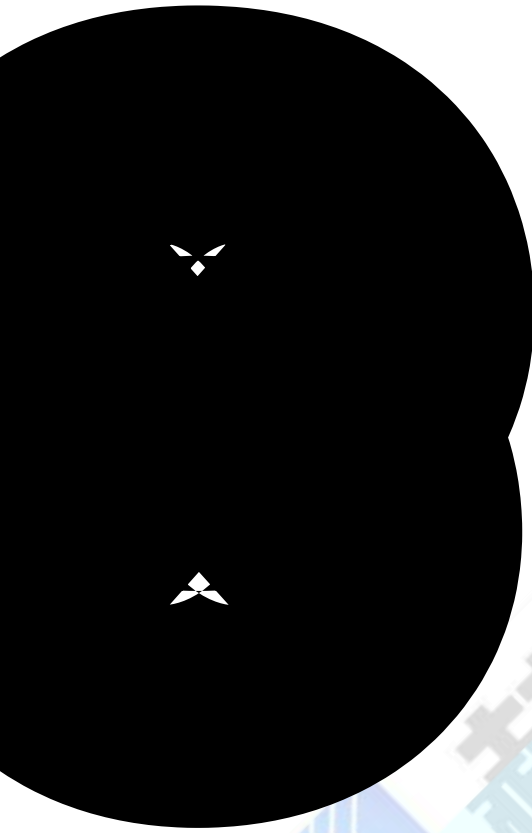

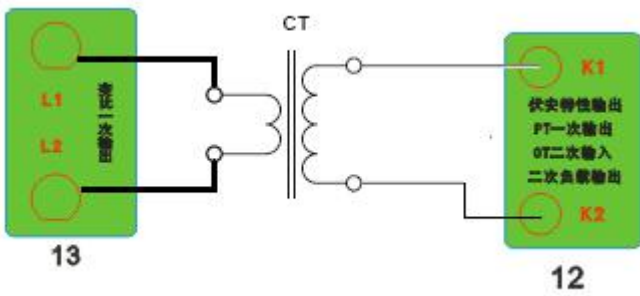
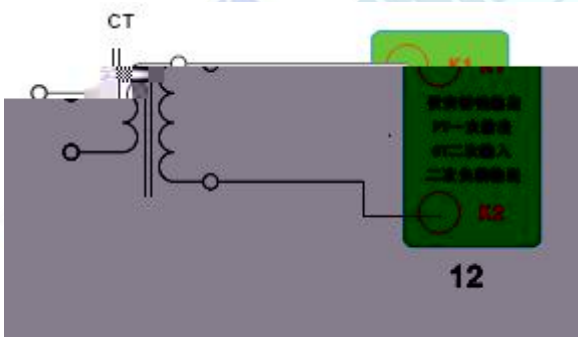
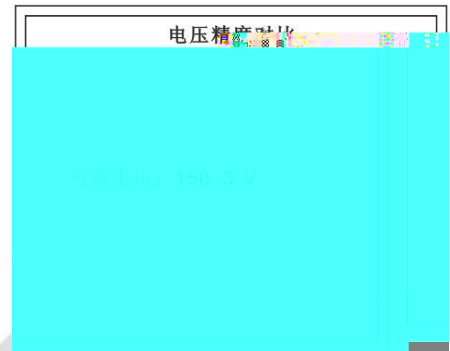

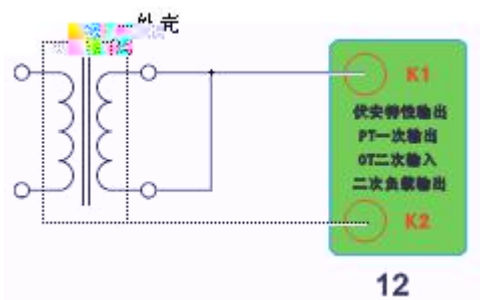
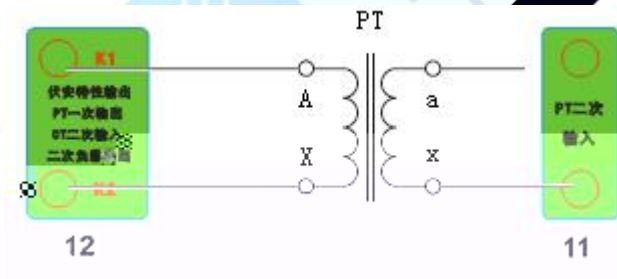
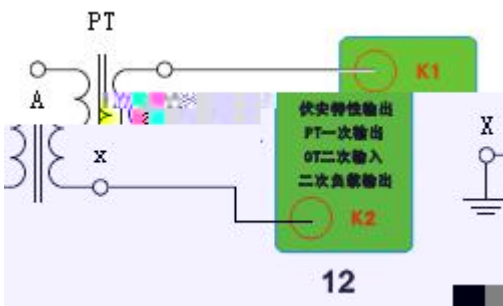
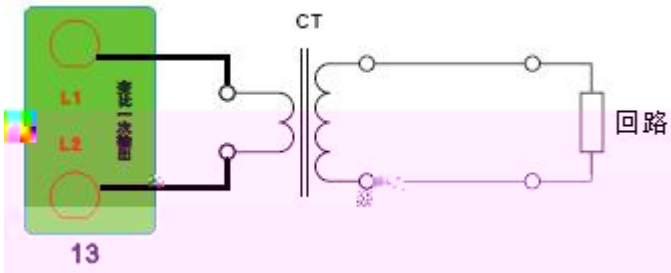

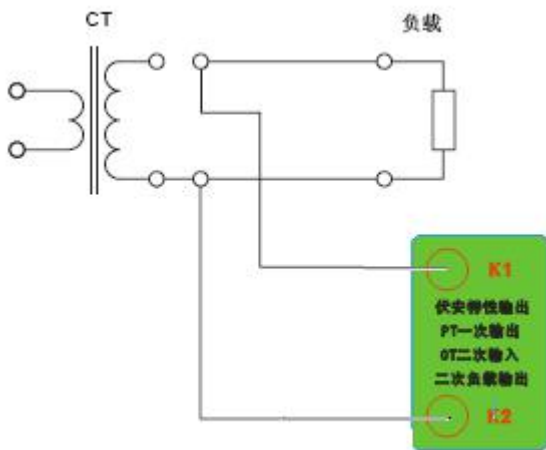
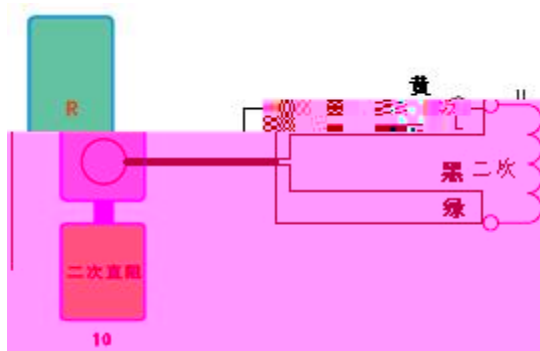

"

"

"

"

1

2

1.

2

1

2

3

2

24

027-83267669

24

48

4